



## ***Light Bee Off-road Motorcycle Owner's Manual***



Scan the QR code above to get the latest Owner's Manual and other supporting materials.



**Surron official website:**  
**[www.sur-ron.com](http://www.sur-ron.com)**

The actual product appearance and function may not be consistent with the contents of the manual due to technical upgrades and firmware updates. Please refer to the actual product to get the latest features and safety guidelines. You may also visit the company's official website to review the latest electronic brochures.

**Off-road electric motorcycle is used in restricted area ONLY.**

Please read the manual carefully before using this product. Do not use this product until you understand the features of this bike. Please keep this manual properly.





## **WARNING**

- Do not ride bike into the water, otherwise it will damage the battery and motor, and even cause personal injury.
- When riding, please wear a safety helmet and obey the local traffic law and regulations.
- Do not ride when the battery compartment cap is not fully secure.
- Please take out the battery before washing the bike. Do not apply the high-pressure washer direct on the battery or other electrical parts.

Congratulations and thank you for purchasing the Surron products. We appreciate your choice and trust in Surron.

Let's enjoy the revolutionary riding experience together.



Scan the QR code above to get the latest Owner's Manual and other supporting materials.

<b>Welcome</b> .....	1
VIN Number .....	1
<b>Label Position</b> .....	2
<b>Safety Instructions</b> .....	3
Requirements For Riding Conditions.....	4
Pre-riding Inspection .....	5
Riding Instructions .....	5
Usage Instructions.....	6
<b>Function Diagram</b> .....	7
<b>Installation Instructions</b> .....	9
Install Handlebars.....	9
Install Headlight.....	9
Install Front Brake and Throttle .....	10
Install Throttle Cables .....	11
Install Front Wheel .....	12
Install Number Plate.....	14
Install Front Fender .....	14
<b>How to Ride</b> .....	15
Braking .....	15
Install Battery .....	16
Parking .....	17
<b>Well Prepared Before Riding</b> .....	18
Check Tires.....	18
Check Instrument, Horn, and Brakes.....	18
Check Handlebars .....	18

Adjust Shock Absorbers .....	18
<b>General Operation</b> .....	18
<b>How to Charge</b> .....	20
Charging.....	20
Portable Charger.....	20
Precautions for Charging .....	22
<b>Specifications</b> .....	23
<b>Other Statements</b> .....	24
Circuit Diagram .....	25
<b>Troubleshooting</b> .....	27
<b>Maintenance Guidance</b> .....	29
Check Parts .....	29
Check Operational Unit.....	30
Check the Battery .....	31
Charging and Charger Usage.....	31
Motor and Controller Usage and Maintenance.....	31
Replace Fuse.....	32
<b>CONDITION OF WARRANTY</b> .....	33

## Welcome

Thank you for choosing the Surron Light Bee electric off-road motorcycle. This product conforms with quality standard of Chongqing Qilong Technology Co.,Ltd.



The pictures in this manual are for reference only. Please refer to the actual appearance and functions of the bike.

For your safety, please read this manual carefully before riding the bike. Please keep this manual properly. Do not ride until you fully understand this bike. Do not use the bike until you are familiar with its performance, operation, and maintenance. All pictures in this manual are for reference only. This manual contains the word WARNING to indicate something that could hurt you or others. It also contains the word CAUTION to indicate things that could damage your bike.

### Bike Vehicle Identification Number (VIN) Label

## Label Position

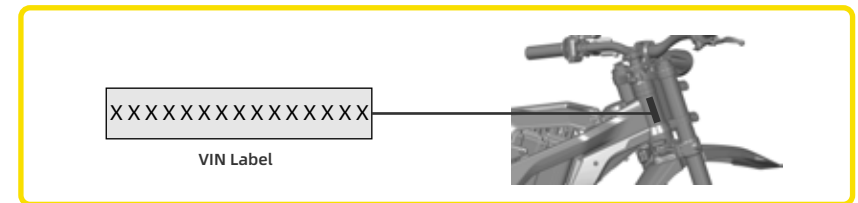
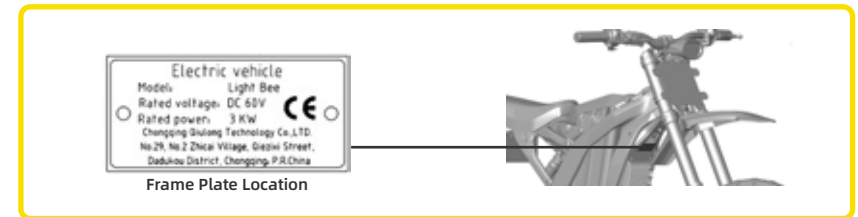
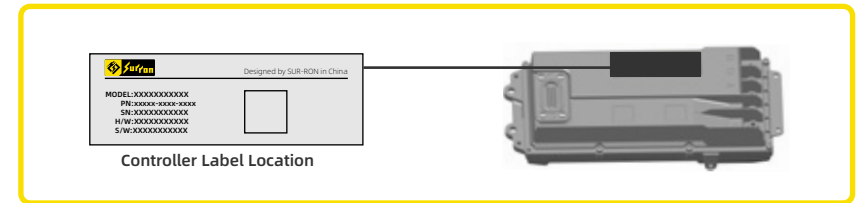
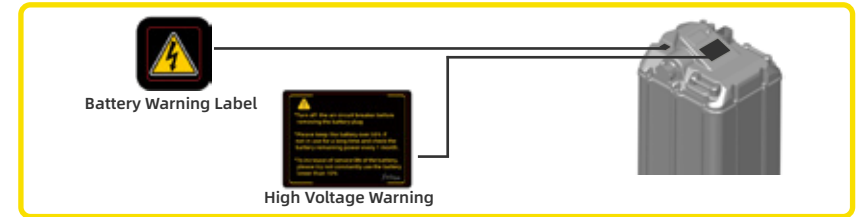
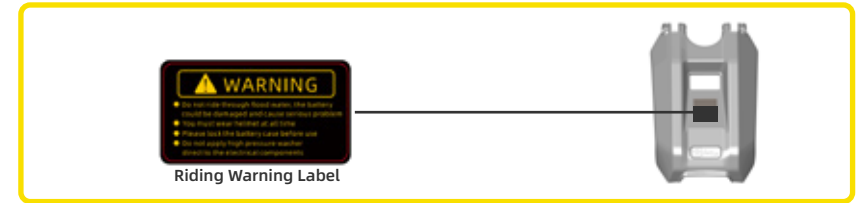

## Safety Instructions

- According to the local laws and regulations, it is prohibited to ride in public road and bike lanes.
- This is a performance motorcycle and should be treated with extreme caution. You are obligated to know the laws in your area and to comply with related laws and traffic rules.
- User under 18 years old is not allowed to use this product.
- Before using this product, you must have motorcycle riding license and are recommended to have the necessary proper motorcycle riding skills after professional training.
- Read all additional warnings and product instructions in this Owner's Manual, as well as safety labels, before operating your electric motorcycle. Please find an open and safe place to practice in order to fully understand the bike and get the basic riding skills of the bike and know its structure, which is the premise of safe riding.
- Never permit a guest to ride your electric motorcycle without proper instruction. Do not lend this bike to people who are unfamiliar with it, so as to avoid injury. Please make sure that the rider (you or others) has read the instructions and watched the instructional video before riding alone. Persons unwilling or unable to take responsibility for their actions should not use this motorcycle. You assume all responsibility while operating your bike.
- Proper safety gear, including a regionally approved helmet, goggles, riding boots, gloves, and protections should be worn while riding to reduce the risk of potential injury.
- Do not park inside the building, evacuation staircases, walkways and emergency exits.
- Follow the local fire hazard regulations and laws. Do not charge or park in residential buildings. Charging should be kept away from combustibles and never over charging.
- This product is ridden by one person only, please do not take any passenger or carrying other items.
- When riding, please wear loose, cuff-tightened clothes in bright colors which are

supposed to ensure your safety. Do not wear slippers or high heels when riding.

- This product contains many electrical parts, so please do not leave it in the rain for too long.
- Precautions for bike washing: please remove the battery before washing. It is prohibited to use high-pressure washer to directly wash the battery or other electrical parts.
- Do not immerse the battery in water. (With damaged appearance, the waterproof performance of the battery will be damaged.) The wading depth cannot exceed the center of the wheel, otherwise it may damage the battery and cause severe injury. It is forbidden to charge the battery under the circumstances above, otherwise it will cause fire, burning or even explosion.
- Modifications to the Light Bee may render the vehicle unsafe and may cause severe personal injury. For your safety, please do not modify this product without the manufacturer's permission. Surron will not take liability for non-approved modifications. If your parts on the bike need to be replaced, please contact your local authorized dealer.
- If alarm or warning code is triggered, please stop using the bike immediately and contact your local authorized dealer for professional guidance or maintenance service.

### Requirements For Riding Conditions:

- Do not ride in extreme weather or if the rider is not in good health condition. When riding in the rain or in the snow, braking distance will be extended, so please avoid riding in heavy rain and other extreme weather conditions.
- Ride slowly and be careful under the complicated road conditions. When riding this bike at high speed over obstacles including uneven, wet, loose ground, steep slope or sharp bend, you may lose control of riding resulting in collision, fall or injury.
- Please avoid riding in heavy rain or ponding area. When the depth of the water on the road exceeds the wheel center, it may affect the function of the motor and the brake. This bike may be used in the rain and snow, but not for long time deep wading. The recommended wading depth is within 20cm.
- The working temperature of this product is -10~45°C (-50°F~113°F) and storage temperature is -10~50°C (-50°F~122°F). The recommended storage temperature is 10°C to 30°C (50°F~86°F). Please store or ride under the temperature within the range above.

Requirements For Riders: (the following persons shall not ride the product)

- I .Persons under the age of 18.
- II .Pregnant women or persons unable to engage in vigorous physical activity due to illness.
- III.Persons under the influence of alcohol or drugs.

#### Pre-riding Inspection

- Check if tires have no cracks, no abnormal abrasion, no nails, stones, glass and other foreign bodies embedded in.
- Tire pressure of 32.6 psi (225 kPa) is required for normal riding.
- Check if axle screws are tightened.
- Check if the handlebars and the front and rear wheels are fixed: to ensure that the handlebars are fixed, the front and rear wheels are stable without shaking, and can work normally.
- Check if the reflector is broken or contaminated.
- Check the status of power circuit and lighting circuit to ensure operate normally
- Check if the front and rear brake system can work normally.
- Make sure the battery capacity meets the riding requirements.
- Check the torque of spokes: tighten it immediately if loose (1.5N·m-2.5N·m)
- Check if the throttle is smooth without stuck and if it can return to idle position normally.
- Check the chain condition: the chain has its floating space under normal conditions. If it gets stuck, please clean and lubricate the chain.
- Check the belt condition: Belt silencer can be used to eliminate the abnormal sound. Please clean the belt if there are any obstacles.
- Check if the inner tube of the front fork is clean.
- Check the back shock absorption inner tube is clean.
- Check if the front and rear brakes can brake normally and ensure there is no damage to the brake cable.

#### Riding Instructions:

- When riding, do not use mobile phone, camera, earphones, earplugs, etc, to avoid distraction.
- Read all additional warnings and product instructions in this Owner's Manual as well as

safety labels before operating your electric motorcycle. Please find an open and safe place to practice in order to fully understand the bike and get the basic riding skills and be familiar with its structure, which is the premise of safe riding. Proper safety gear, including a regionally approved helmet, goggles, riding boots, gloves, and protections should be worn while riding to reduce the risk of potential injury. According to the local laws and regulations, it is prohibited to ride in public road and bike lanes.

- During normal riding, do not use sudden acceleration and hard brake in order to save battery power, protect parts on the bike, improve range and bike's service life.
- If any abnormality occurs while riding, please stop riding immediately. Do not use this product until the cause of the abnormality is identified and repaired. Please contact your local authorized dealer immediately.

#### Usage Instructions:

- Place the product on a flat road and do not forget to turn off the key switch. Otherwise, it could cause the bike slip which would cause injury to you and others. Do not place the bike on a slope or on soft ground to prevent the bike from falling over!
- Please be sure to use the manufacturer's lithium-ion battery charger. The charger input voltage is 110V. Store the product safely before charging. Do not charge the bike if the charger and charging port are damaged. Do not charge or park in the non-parking area. Make sure the bike stays away from combustibles when charging and disconnect the power supply after fully charged.
- Do not charge the battery below 0°C (32°F), otherwise the battery cells will be damaged. Please charge the battery when the temperature is appropriate for charging .

## Function Diagram

Please identify the parts of the bike according to the labels in the picture and familiarize yourself with the bike.

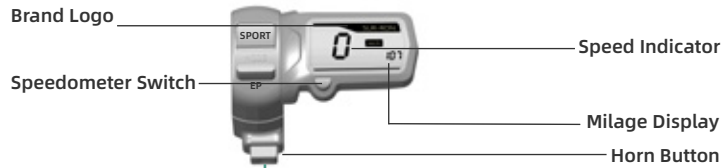

### Combination Switch & Speedometer

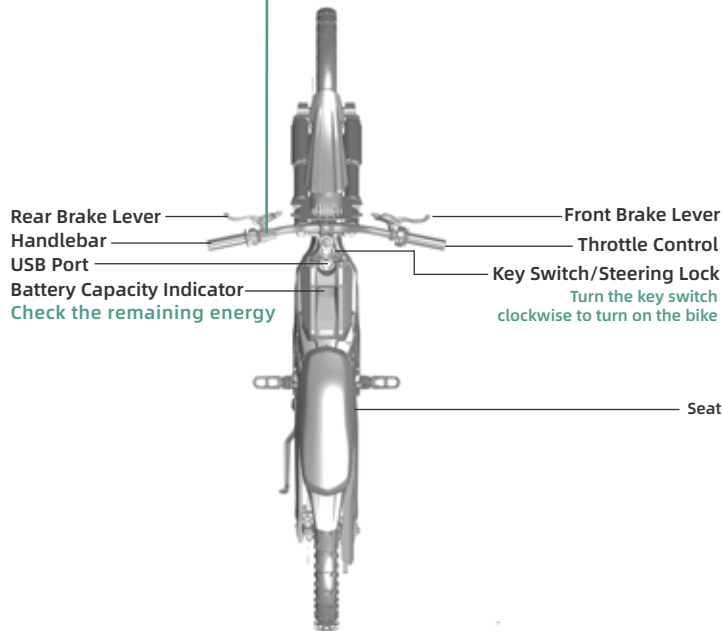

### EP MODE

Limit the bike's power and maximum speed, suitable for beginners and situations requiring long range

### SPORT MODE

Full power output, suitable for trail and off-road riding.

Speedometer Switch:

- Momentarily press the switch will display between current speed and total mileage to current maximum speed and current mileage.
- Long press to clear the maximum speed and mileage.
- Keep pressing the switch and turn on the key switch. After the bike turned ON, still press the switch for another 4 seconds, and then the speedometer display will switch from kilometer per hour to miles per hour.

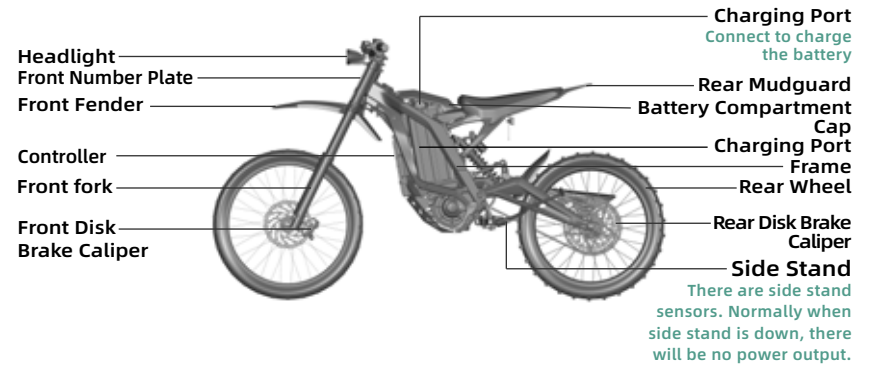

**⚠ Note:** If the temperature of the motor or controller is too high, or the battery power is too low, the bike will automatically reduce the power to protect the bike.

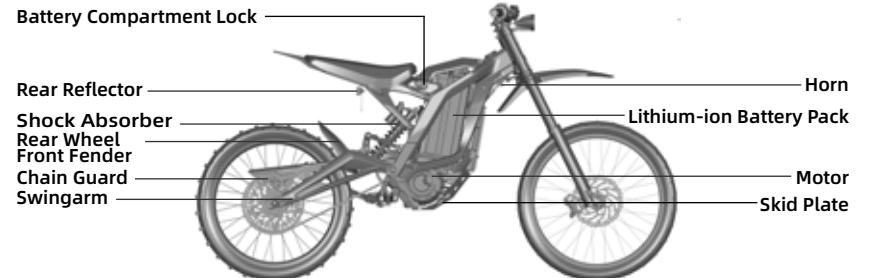

**⚠ Note:** For the purpose of maintenance and service, each bike has its unique VIN number and motor number, please keep these numbers properly. The VIN number is place on the steering tube and the motor serial number is engraved on the body of the motor.

## Installation Instructions

### Install Handlebars

1. Use a 4# inner hexagon wrench, loose and remove the four screws and then take off the stem cover.

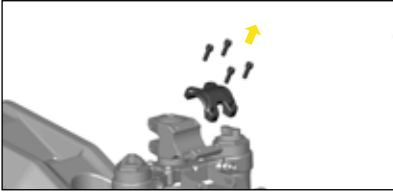

2. Fix the front brake and throttle on the handlebar.

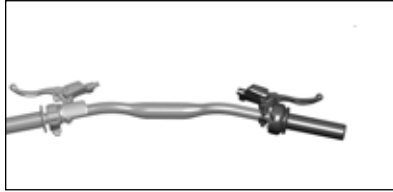

3. Install handlebars, fix the stem cap, adjust the angle and position of handlebars according to personal riding habits.

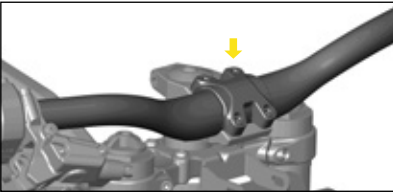

4. Tighten the four screws with a torque of 6 to 8 Nm.

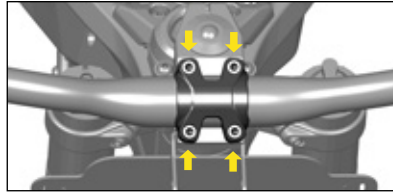

### Install Headlight

1. Fix the headlight to the mounting bracket of the connecting plate on the front fork.

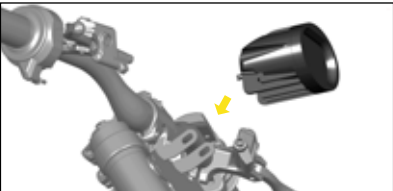

2. Adjust the position and tighten the screws on both sides.

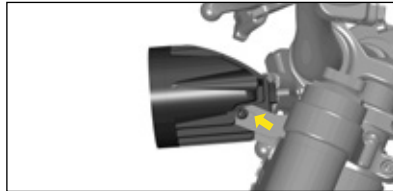

### Install Front Brake and Throttle

1. As shown in the picture, after installing the throttle, roll it back 2mm.

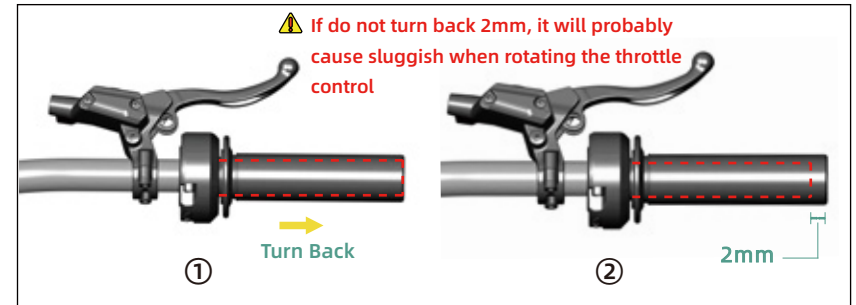

2. As shown in the figure above, the gap between the front brake cylinder and the throttle grip is no less than 12mm. (It can be adjusted according to personal riding habits).

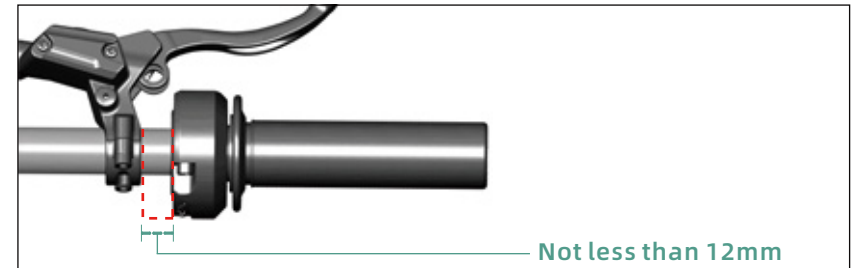

3. When installing front brake, the distance between brake and throttle should not be closer than 12mm. (It can be adjusted according to personal riding habits.)

And to avoid interference between the front brake lever and the throttle case, the front brake lever should be perpendicular to the flat side of the throttle case. (It can be adjusted according to personal riding habits.)

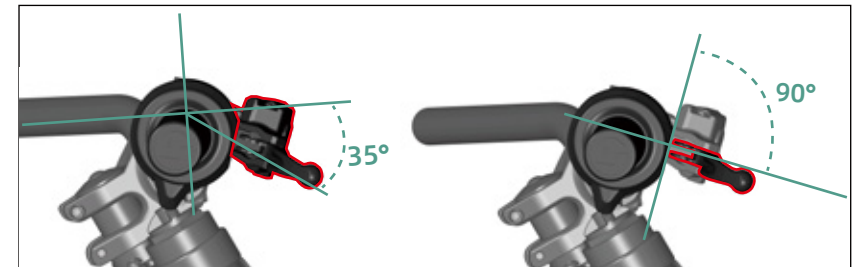



4. Use a 4#, 5# inner hexagon wrenches respectively to tighten the throttle and the front brake; tighten the throttle and then release it to ensure that it can naturally return to the original position.

(If it gets stuck, check the position of the throttle position and its cable position.)

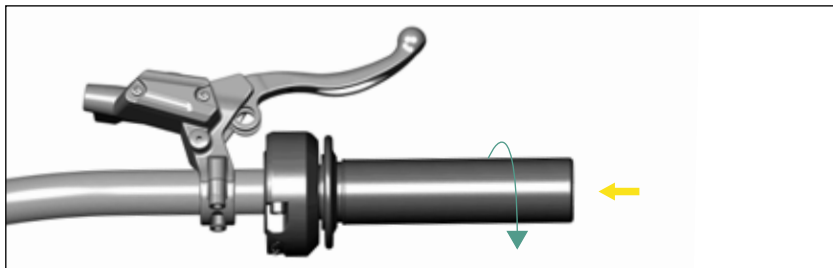

### Install Throttle Cables

1. As shown in the picture, fix the cable tie of the throttle, the left combination switch and the cables of the speedometer cable on the handlebars respectively, and cut the extra tie.

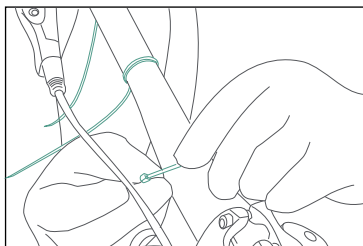

2. Organize the cables to make sure there is no bending around the tube.

Note: There is no need in tying up the brake hose and brake signal line.

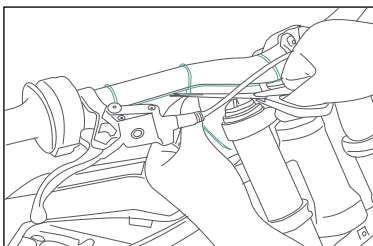
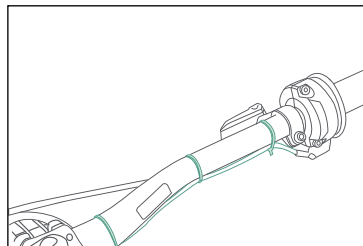

Note: Use rubber tie to fix the rear brake hose and combination switch cable.

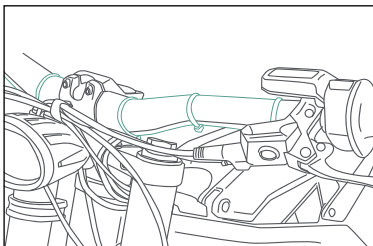

Note: After the cables fixed, rotate the handlebars to test and ensure that all wiring harness is loose and not strained.

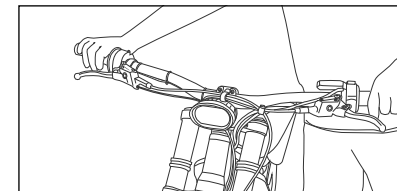
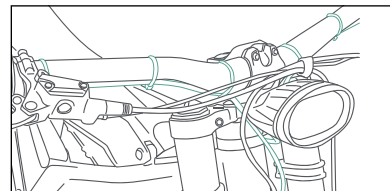

⚠ CAUTION: Do not tie the cable together when installing the headlight, front brake and throttler.

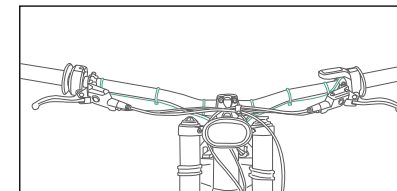
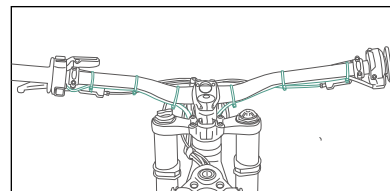

### Install Front Wheel

1. Loose the 4 front axle lock bolts at the lower end of the front fork with a 4# inner hexagon wrenches.

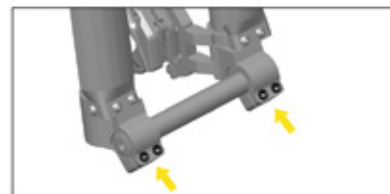

2. Use an 8# inner hexagon wrenches to remove the front axle lock nuts on both sides. Tap it gently with a rubber hammer to remove the front axle.

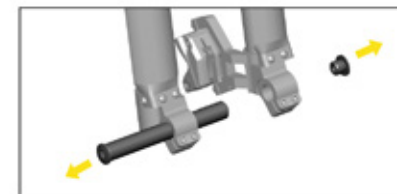

3. Install the front wheel bushings on both sides gently, make sure the bushing is properly installed and all the seals are well placed, the bushing can move freely.

\* Do not damage the seal ring.



4. Remove the brake caliper clamping block and place the front wheels at the front wheel mounting point on the front fork.

\* Please pay extra attention to the position of brake disc and brake caliper.

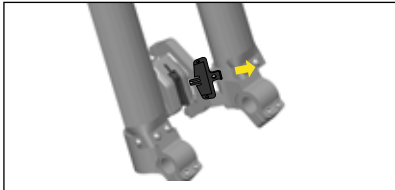

6. Secure the left and right lock nuts with an 8# inner hexagon wrench.

\* Pre-tightened four screws in case of slipping.



5. Install the front axle through the front fork and then through the front wheel.

\* It can be adjusted according to personal riding habits.

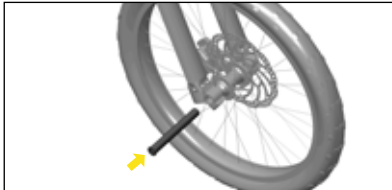

7. Tighten the four bolts at the bottom of the front fork with a 4# inner hexagon wrench.



Do not twist the throttle before sitting firmly to prevent accidents. The side stand is only used to support the bike. Do not lift the side stand before sitting on the bike.

## Install Number Plate

1. Install four 200mm cable ties on the front number plate, as shown in the picture.

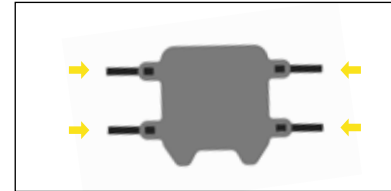

2. Fix the number plate on the front fork.

\* You can hide the wire harness behind the number plate

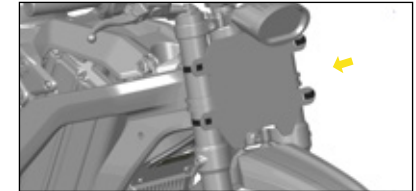

WARNING

For your safety, please wear full-cover off road protective helmet and protective gears. Please take all safety precautions. Do not lend the bike or allow persons who are unfamiliar with the bike and incapable to ride. It is dangerous to ride with one hand only or two hands off the handlebars and ride after drinking.

## Install Front Fender

1. Remove three bolts and T-shaped gaskets as shown in the figure.



2. After removing, pre-install the T-shaped gaskets on the three bolts respectively, and pay attention to the direction of the T-shaped gaskets as shown in the figure.

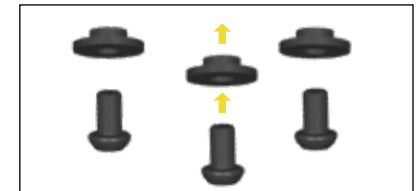

3. Install front fender. Tighten the screws with 5# inner hexagon wrenches with torque of 5 N.m.



## How to Ride

1. Insert the key into the key switch and turn on the switch.
2. Check if each switch, instrument, horn, brake, electricity instrument function well.
3. Before starting the motor: fold up the side stand, sit firmly and turn inward slowly to control speed.

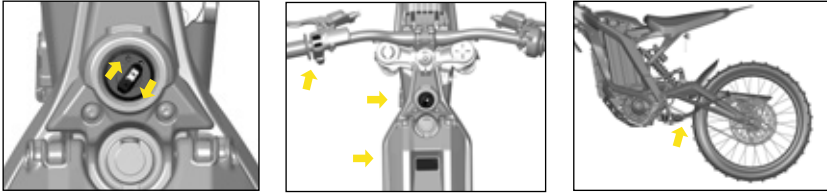

Speed up and reduce acceleration by controlling the throttle. Backward rotation means acceleration; forward rotation means deceleration.



WARNING

Acceleration must be done smoothly and gently. Do not operate violently in case causing damage to bike parts, or even accidents. For the first time of your ride, you are advised to use EP mode. SPORT mode can be used when you are fully familiar with the bike.

## Braking

Release the throttle and pull the brake lever to reduce the speed and stop the bike.

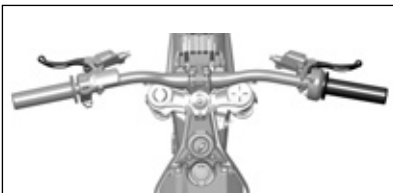

## Install Battery

1. Open the battery box and take out the battery. Insert the key to the battery compartment lock and rotate counterclockwise to unlock; open the battery compartment cap and check the air circuit switch to make sure it switches OFF.
2. Put the battery into the battery compartment cap. The charging port on the left side of the bike, facing out.
3. Connect the main power plug and communication plug.
4. Turn ON the air circuit switch, close the battery compartment cap and remove the key.

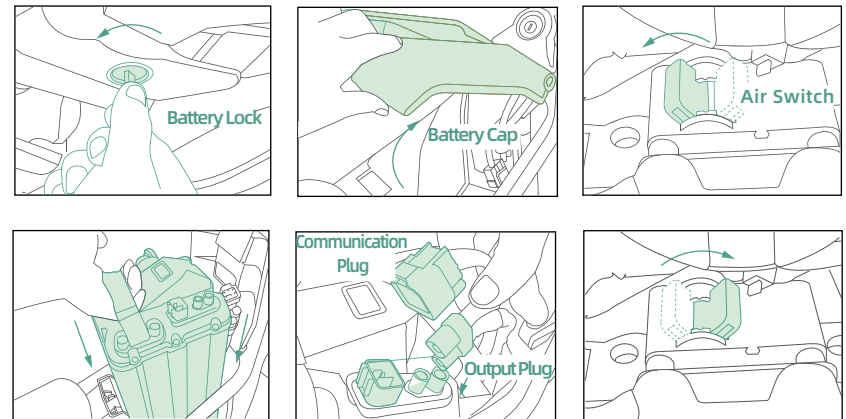

WARNING

To avoid damages or dangers, do not disassemble the battery and please make sure that the key switch is OFF.



WARNING

Please control the grip strength of the brake lever according to the actual situation and gradually increase the force. Do not excessive braking in case the wheel is locked and cause serious damage. Prejudge the road condition in advance carefully and avoid sudden excessive braking, steering and other operations which may cause the sliding and falling, especially in rainy days when the road is slippery and extremely dangerous.

- When riding, sudden excessive braking of the right front brake lever may lead to roll over.
- When riding, sudden excessive braking of the left rear brake lever may lead to skid.



WARNING

It is normal to trigger tilt switch of the power system if bike tip-over occur when riding (power output is cut off, and it can be recovered after righting the bike again). For your safety, please ensure to turn off the key switch before lifting the bike to avoid accidentally twist the throttle and cause serious injury.

## Parking

Pay attention to the road condition, slow down the bike while approaching the parking spot. When the bike stops, turn off the key switch and remove the key. Flip down the side stand to support the bike.



WARNING

Please make sure to turn off the key switch when parking, to avoid accidentally twist the throttle and cause serious injury. Turn off the key switch and remove the key before leaving the bike.

- ⚠ Be cautious and ride slow in complex road conditions.
- ⚠ It is prohibited to carry people or items on the bike.
- ⚠ Do not ride when you are tired or in extreme weather.
- ⚠ Do not ride in the water, otherwise it may damage the battery or even cause personal injury.
- ⚠ Please hold the handlebars with both hands and do not ride overspeed.
- ⚠ Slow down before turning.
- ⚠ Do not use mobile phone, camera, earphones, earplugs, etc during riding.

## Well Prepared Before Riding

⚠ Please make sure that you have fully read all the details in p03 and check the following items carefully.

### Check Tires

Make sure both tires are in good conditions.

Normal tire pressure is 32.6 psi (225 kPa). Low tire pressure will lead to abnormal wear, poor steering, lower speed, and shorten the range.

Extreme high tire pressure will lead to abnormal wear, poor riding experience, and even tire explosion.

### Check Instrument, Horn, and Brakes

Check if all functions of the instrument are displayed normally.

Check if the horn works properly.

Hold the left and right brake levers respectively to check if the front and rear brakes work normally.

### Check Handlebars

Handlebars need to be fixed tighten and turn freely.

### Adjust Shock Absorbers

Please adjust the front and rear shock absorbers according to the actual situations.

## General Operation

The bike's power is cut off (When the power is on but motor not running)

- Side stand switch (with the side stand is down, there will be no power output when turning the throttle.)
- Tilt switch (1-2 seconds after the bike falls over, tilt switch will cut the power output)
- Motor overheating
- Battery overheating
- Low Battery capacity
- Controller overheating



## Low Power Mode

① When the battery capacity is less than 15%, the controller will reduce the output to protect the battery, and then the SPORT mode can no longer be used.

\* The battery percentage display may be inaccurate because of the battery condition.

② When the battery capacity is less than 5%, a heavy load (such as sudden acceleration or climb steep slope, etc.) will make the controller get into the low voltage protection, and then the bike will stop running. If it doesn't get charged in time, the battery may get into the over-discharge protection mode at any time (the over-discharge protection can effectively protect the cell, and needs to be reactivated by the charging) .

③ Controller overheating (when the working temperature exceeds 85°C (185°F), the bike will reduce the power and get into the EP mode. If the overheating continues and exceeds 100°C (212°F), it will cut off the output.)

④ Motor overheating (when the working temperature exceeds 130°C (266°F), the bike will reduce the power and get into the EP mode. If the overheating exceeds 150°C (302°F), it will cut off the output.)

## Working Conditions

● When the temperature is below 0°C (32°F), the battery capacity may correspond to 80% of its normal capacity, and to ride in the SPORT mode is not recommended.

● When the temperature is higher than 40°C (104°F), it is recommended not to ride at full power for a long time.

## Riding In The Water

Electrical parts of Light Bee off-road motorcycle are all designed to have basic waterproofing ability. The wading depth is no more than 20cm, and it cannot be under water for a long time, especially when the motor is in high temperature. When the bike is under water, its internal air will contract, leading to damage while water absorption from the oil seal and

cable position into the interior. The followings are the IP level of each component:

- Battery, motor: IP65
- Controller: IP67
- Connector: IP55

## How to Charge



Do not charge the battery below 0°C (32°F), otherwise the battery will be damaged. Wait until the temperature is appropriate to charge. Battery recycling and utilization instructions: damaged or used battery cannot be dismantled without permission and it should be handed over to the manufacturer or designated after-sales service centers for recycling or maintenance. Do not throw away the battery.

\* When the bike is not used for more than a month, be sure to turn off the air circuit switch or remove the power plug, and store the bike when it is fully charged.

\* Close the battery compartment cap on the charging port when not charging.

## Charging

Connect the charger to the charging port and connect the charger to the proper power supply.

## Portable Charger

1. Make sure the key switch is OFF. Insert the key to the battery compartment lock, press the battery compartment cap, turn the key counterclockwise, open the battery compartment cap, and turn off the air circuit switch.

Note: The foam under the new battery compartment has a large adhesive force with the battery, you may be unable to open the battery compartment with just the key. When it happens you need to press the battery compartment cap before opening.

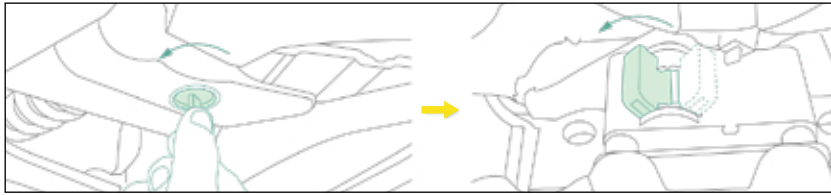

After using the battery for a while, if there is a space between the bottom of the battery and the bottom battery compartment, you may pick up the auxiliary foam pad and stick at the bottom of the battery compartment to keep the battery stable. (The auxiliary foam pad is in the accessory tool box in the original bike package)

2. Pull up and remove the discharge plug and communication plug from the battery vertically.

3. Take out the battery pack and close the battery compartment cap.

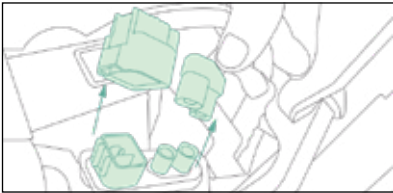

4. Connect the charger to the charging port first and then connect to the power supply at the other side.

\*The charger indicator blinking red indicates that the charger is being charging. When the battery is fully charged, the green light is stay on. Remember to cut off power when fully charged. Please turn on the air circuit switch after the battery is connected to the bike.



#### Precautions for Charging

- When charging, keep the battery in a safe place where children can't reach.
- Do not cover the charger when charging. This charger is for indoor use, please make sure to use it in a dry, well-ventilated environment.
- When you smell something peculiar or find that the temperature of the charger or battery pack is too high, or fully charged indicator never show up after a few hours, please stop charging immediately and send your battery to the local authorized dealer for inspection and maintenance.



**WARNING**

Please make sure to use the manufacturer's lithium-ion battery charger. When replacing the charger, it should match the model of our storage battery. Turn off the air circuit switch before installing or removing the battery from the bike. Disconnect or connect the plug while power cable connected may shorten the battery service life. It is risky to connect the power cable while the air circuit switch is on, it might cause spark and damaged the plug, it may even damage the battery. The charger will be automatically turned off when the battery is fully charged, however, please avoid leaving the charger connected to the power supply for too long.

## Specifications

Items	QL3000DY
Brand	Light Bee Off-road Electric Motorcycle
Dimension	1885mmX780mmX1050mm
Ground Clearance	270mm
Wheel Base	1255mm
Seat Height	830mm
Dry/Curb Weight	45kg/56kg
Maximum Load	75kg
Wheel Base	200mm
Rear Shock/Wheel Travel	85/210mm
Power System	Mid-drive BLDC Motor
	FOC Sine Wave Controller
Rated Power	3000W
Maximum Power	6000W
Range	70km (at35-40km/h)
Battery Type	60V/34Ah 60V/38.5Ah 60V/40Ah Lithium-Ion Removable Battery Pack
Maximum Torque	250N.m
Top speed	75km/h
Charging Time	4h
Waterproof Rate	IP65
Bike System Type	Aluminum Alloy
Tire	Front Wheel: 70/100-19
	Rear Wheel: 70/100-19
Riding Mode	SPORTS + ECO Mode
Assistance Functions	Regen(on SPORTS Mode)
USB Charger	USB 5V2.4A
Front and Rear Brakes	230mm Hydraulic Disc Brake
Secondary Transmission System	Chain 420- 106Links
Charger Type	DC-60V (10A)

\*For the battery loaded in the vehicle, please refer to the battery purchased.

\*The range varies greatly depending on the test environment. The range is measured under conditions of 75kg rider, ambient temperature 28-35°C, and constant speed 35-40km/h.

## Other Statements

1.Chongqing Qiulong Technology Co.,Ltd., continuously improves the product quality and performance. Therefore, this manual contains the most latest available product information at the time of printing. Because of this, it is possible that your motorcycle may differ from the information supplied in this Owner's Manual. If there is any difference between the logo or picture in the manual and the actual product, please refer to the actual product.

2.To the extent permitted by law, Chongqing Qiulong Technology Co.,Ltd., reserves rights to interpret and explain this statement.

3.This declaration shall be governed by the laws of the People's Republic of China (except the laws of Hong Kong and Macao Special Administrative Regions and Taiwan Region of China). Chongqing Qiulong Technology Co.,Ltd., is not liable for all claims, liabilities and losses caused or likely to be resulted from consumers' violation of the terms above. Riders should be responsible for unforeseeable or unavoidable risks while riding.

4.If you want to resell or give away your Surrón Light Bee off-road motorcycle, please do not forget to pass along this manual as it is part of the product. If you have any questions, please contact Chongqing Qiulong Technology Co.,Ltd., Thank you again for your choice and trust in us.

# Circuit Diagram

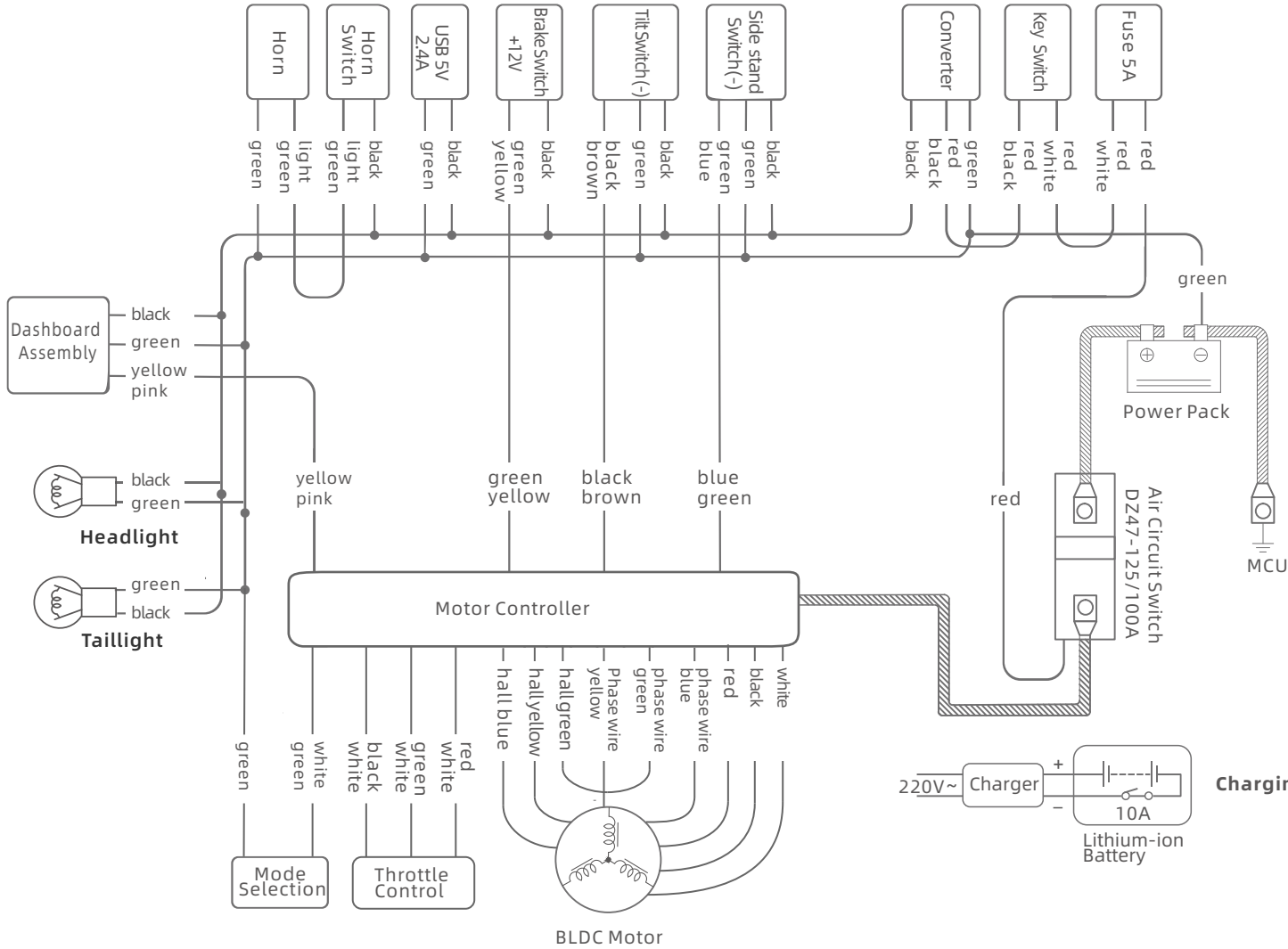

Charging Circuit Protection Diagram



## Troubleshooting

Item	Fault Cause	Troubleshooting Methods
Power On Motor not working	1.The battery cable is loose	1. Check whether the cable is securely connected 2. The plug connection is stable 3. Reconnect and secure the terminal 4. Check the brake lever and brake switch
	2.Throttle is loose or fall off	
	3.The motor cable is loose or disconnected	
	4.Brake lever cannot return to idle or malfunctioned	
Speed failure or low maximum speed	1.Bike dash out protection	1. Restart the bike 2. Wait for the bike temperature to return to normal 3. Check whether the cables and plugs of the brake, tilt switch, and side stand switch are securely connected 4. Check whether the cable of the throttle is properly connected to the plug
	2.Temperature protection	
	3.Power-off protection	
	4.The throttle is malfunctioned	
Insufficient range for one charge	1. Low tires pressure	1. Restart the bike 2. Wait for the bike temperature to return to normal 3. Check whether the cables and plugs of the brake, tilt switch, and side stand switch are securely connected 4. Check whether the cable of the throttle is properly connected to the plug
	2.The charger is malfunctioned	
	3.Improper brake pads adjustment	
	4. The battery is overuse or damaged	
	5. More uphill, frequent acceleration and deceleration, heavy load	
After connecting the power supply, the charger did not work normally, and the battery capacity no display	1. The battery over discharge protection occurs because the battery has not been charged for a long time or improperly stored	1. Connect the plug to the charging port on battery first and then connect to the power supply, the indicator light of the charger blinks alternately red and green 2. Unplug and re-connect the connector of the charger and the power supply once; the indicator of the charger rapidly blinks red for 20 seconds at a frequency of 0.5S 3. After 20 seconds, the red indicator light keeps on for 10 seconds. Within 10 seconds, unplug and re-connector between the charger power supply once 4. The enforcement charging function of the charger starts, and the charger enters the normal charging process Note: A. Do not remove or insert the AC plug for 20 seconds in Step 2. Otherwise, you need to start all over from Step 1. B. Unplug and re-connect to the power supply process in Step 3 need to be done within 10 seconds after the red light is on. If not, restart from Step 1

Item	Fault Cause	Troubleshooting Methods
Charger not working	1.The connector of the charger is loose or disconnected	1. Insert the plug or connector firmly to open the battery compartment cap 2. Open the battery compartment cap and connect the plug firmly 3. Activate the battery
	2.The connector of the battery power cable is loose	
	3. The battery over discharge and need to be Reactivate	
Abnormal sound when riding	1.The tightness of the chain is inappropriate	1. Adjust the tightness of the secondary chain 2. Adjust the tightness of the Primary belt 3. Dust in brake disc and brake pads, need to be cleaned; the brake calipers are loose or improperly installed
	2.Belt tightness is inappropriate	
	3. The braking system is not properly installed	
Other Fault	1. When you encounter a fault that cannot be solved or identified by yourself according to the instructions above	In case of the above situation, please contact the local authorized dealer, do not disassemble the above parts without authorization, otherwise it might void your warranty
	2.The motor, controller, charger, and battery are damaged	

## Maintenance Guidance

In principle, the first inspection (also known as the first maintenance) can be done at 10-30km if ride normally.

### Check Parts

1. The tightness of the spokes on the front and rear wheels.
2. If there is a gap in the headset.
3. Check the tightness of chain.
4. Belt tightness inspection. (There may be some friction on the new belt, which can be waxed on both sides of the belt.)
5. Suspension adjustment. Check if there is oil leakage, and if the compression and rebound damping is in the correct position. (Note: During adjustment, do not turn the adjusting knob to the extreme position.)
6. Check the tightness of all screws on the handlebars.

**WARNING: During the whole maintenance process, the bike cannot be powered on, which means you cannot do maintenance with the bike is powered on.**

Extra attention should be paid to your safety during the inspection.

1. Choose a wide, flat area to park your bike.
2. When inspection is needed, it should be carried out in a safe place and pay close attention to the surrounding environment.
3. If there is any abnormality during the inspection, please rectify the abnormality before riding. If the problem is difficult for you to solve, please contact Surron or the local authorized dealer.

### CAUTION

1. The front and rear brakes are disc brakes. When the brake pads are worn severely, please replace them as soon as possible.

2. Keep the disc brake system clean in daily basis use and avoid long-term adhesion of sediment, especially oil pollution.

### Check Operational Unit

1. Check if the suspension is bent, deformed, or damaged.  
Check if the front fork is damaged, loose or oil leakage and other faults. Shake the handlebars up and down to check whether there is any abnormal sound caused by the front fork fault. If the front fork is malfunctioned, please contact Surron or the local authorized dealer.
  2. Check Brakes  
Check if the free space of the brake lever is within the specified range (15-30mm). Adjust If it does not meet the requirements after measurement.  
3. Check if the brakes function well. Please ride at low speed on dry flat road for inspection, and use the front and rear brakes respectively to check their braking effective.
  4. Check Tires  
The tires will be damaged by glass, stones and other matter on the ground. Please pay attention to the road condition when riding. Avoid riding in places where tires may be easily damaged. In addition, you should often check if the tires have distinct cracks and other damages.
    - 1) Check the tire pressure with the tire pressure gauge when in the cooling condition.
    - 2) Check if there are cracks, damages or abnormal wear.
    - 3) Check if the spokes of the wheel are loose.
    - 4) Check the tightness of the chain. Up and down 10-20mm.
    - 5) Check the depth of tire grooves.  
Check tire wear, groove depth. If wear reached 2/3 of the convex block, the tire should be replaced. When there is abnormal sound or swing in the tire, please contact your local authorized dealer for inspection and maintenance.  
The pivot shaft nut locking torque should be 30 N·m, and the rear axle nut locking torque should be 40 N·m, The front axle screw locking torque depend on the front fork.
-  CAUTION**
1. The belt tension has been adjusted before delivery. Please do not adjust it without permission.
  2. Hold the brake lever tightly. If the braking performance is still not good, check the

cleanness of the discs.

If the problem cannot be solved, please contact your local authorized dealer for inspection.

#### Check the Battery

##### 1. Check the Power

The bike is powered by a sealed lithium-ion battery. The battery should be fully charged before the inspection. Use a multimeter to test the positive and negative voltage of the discharge port, the normal full voltage should be between 67-67.2V.

##### 2. Check Battery Appearance

Check if the battery's upper and lower sealing caps and the Lcd screen are damaged. It will cause water get into the power pack if the sealing is damaged. Contact the local authorized dealer if the battery case or cap is damaged.

#### ⚠ CAUTION

1. Before installing or removing the battery, please close the key switch and turn off the air circuit switch, and close the sealant cap of charging port.

2. If the battery cannot be put into the battery compartment, please take out the battery and check if the battery is stuck by other objects such as cable harness.

3. It is recommended that in winter the indoor temperature for battery storage should be above 0°C (32°F) and the battery remaining capacity should be checked regularly.

#### Charging and Charger Usage

1. When charging, you are required to use the OEM charger. Do not use third-party charger, it might damage the battery and cause serious injury.

2. Check if the input voltage of the charger is same with the voltage of the power supply.

3. When the battery is fully charged, the charger will automatically stop charging. Avoid connecting the charger to the power supply for a long time.

4. Users are prohibited to disassemble the battery, disassemble battery without permission may cause serious injury.

5. When the battery is under over-discharge protection, it needs to be re-activated. Please refer to P27 < Troubleshooting > for activation method.

#### Motor and Controller Usage and Maintenance



When the temperature of the motor and the controller is too high or the battery capacity is too low, the bike will automatically reduce the power to protect the powertrain.

1. Check tightness of the motor screws regularly.

2. Check the motor and controller insulation condition regularly.

3. Check the fuse condition regularly.

4. Do not wade in deep water, it might affect the motor operation.

#### ⚠ CAUTION

When the temperature of the motor and the controller is too high or the battery capacity is too low, the bike will automatically reduce the power to protect the powertrain.

#### Replace Fuse

If the speedometer, horn, and headlight do not work after the air circuit switch and key switch are turned ON, the fuse may be melted. If the fuse needs to be replaced, please turn off the air circuit switch first. The operation method is as follows:

1. Open the battery compartment cap, turn off the air circuit switch, take out the battery, the fuse box can be seen in front of the air circuit switch, and open the fuse box. (the fuse box is wrapped with black insulation tape)

##### Turn off the Air Circuit Switch

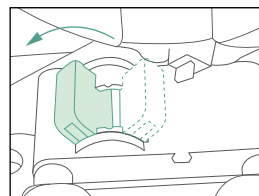

##### Find the fuse box

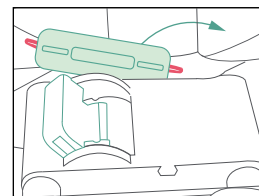

##### Replace it with auxiliary fuse

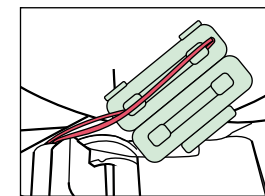

#### ⚠ CAUTION

1. The fuse should be firmly fixed on the fuse stand. If the fuse connecting part is loose, it may cause the fuse to heat up rapidly and then cause other faults and dangers.

- 
2. Replace the fuse with the correct specification. If the fuse doesn't match the requirement, it may fail to protect the system.
  3. If the fuse is melted again after replacement, you should check all the related cables to see if there are still other short circuits.
  4. Avoiding high press washer direct use on the fuse.

### **CONDITION OF WARRANTY**

SURRON hereby warrants the new SURRON bike purchased from an authorized SURRON dealer to be free from defect in materials and workmanship for the period of time stated herein, subject to certain limitations stated herein. This warranty applies only if the bike has been properly set-up and serviced for pre-delivery by an authorized SURRON dealer. The warranty applies only if the motorcycle has been operated and maintained in accordance with the owner's manual or other SURRON literature delivered with the bike. This warranty is void if the ONLINE OWNER'S REGISTRATION/ DEALER PRE-DELIVERY INSPECTION has not been completed in full and entered into SURRON Distributor website within 7 days of purchase by the original selling dealer.